

Pallet Racking, Shelving & Warehouse Solutions

PALLET RACKING

# SAFETY GUIDE



# Pallet racking safety guide

## S.W.L. (Safe Working Load) signs

Total weight capacity per pallet space. ①

Total capacity of load is reduced when uneven or oversized pallets are stored. Refer manufacturers guide. ②

Total capacity for each beam level. ③

Total capacity of bay. ④

Beam width. ⑤

1st Beam level. ⑥

2nd Beam spacing. ⑦

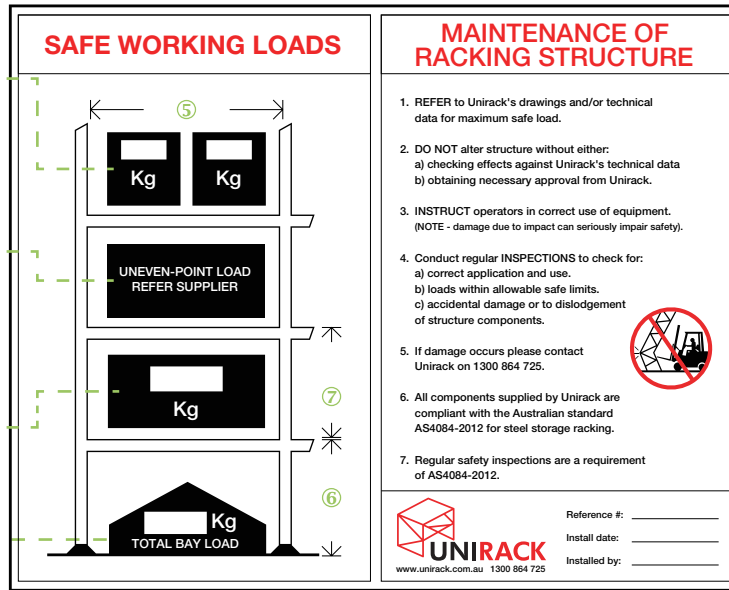

For the sign to meet current regulations it must have the following completed and be placed in a clearly visible location:

Logo shown clearly of the company who supplied the racking.

A reference number which relates to the current design and drawings.

A date that it was installed.

The person and company who completed the installation.

## Correct load placement

**DO NOT STORE AN UNBALANCED LOAD**

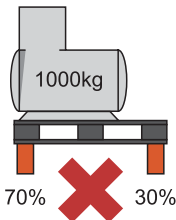

**INCORRECT**  
 Load must be evenly distributed across the pallet.

**ALWAYS DISTRIBUTE LOADS EVENLY**

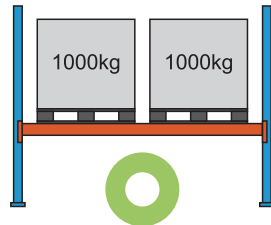

**CORRECT**  
 Good loading practice. Evenly distributed load and effective use of space.

**AVOID STORING LOAD IN THE MIDDLE OF BEAMS**

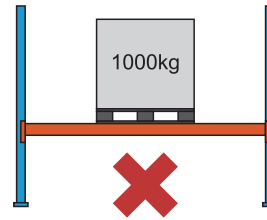

**NOT RECOMMENDED**  
 Badly positioned pallet. Not overloaded but prevents storage of second pallet.

**DO NOT OVERLOAD**

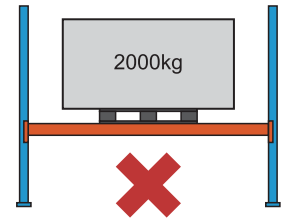

**INCORRECT**  
 Overloaded. Beams designed for 2 x 1000 kg pallets.

### ADELAIDE

98 Regency Rd, Ferryden Park SA 5010  
 Email: adelaide@unirack.com.au  
 Tel: (08) 8244 1033

### BRISBANE

3/853 Nudgee Rd, Northgate QLD 4013  
 Email: brisbane@unirack.com.au  
 Tel: (07) 3088 2284

### HOBART

Email: hobart@unirack.com.au  
 Tel: (03) 8376 9469

### MELBOURNE

22 Commercial Drive, Dandenong South VIC 3175  
 Email: dandenong@unirack.com.au  
 Tel: (03) 8376 9464

### PERTH

Rear 9 Keegan St, O'Connor  
 Email: perth@unirack.com.au  
 Tel: (08) 9331 1222

### SYDNEY

Email: sydney@unirack.com.au  
 Tel: (02) 9637 5908



[www.unirack.com.au](http://www.unirack.com.au)



1300 864 725

# Step by step | Beams safety

Any damaged upright slots should not be used. Move beam up or down to undamaged slots.

If a beam is disengaged, reposition immediately with safety clip in place.

Always replace a beam that has a damaged weld or connector.

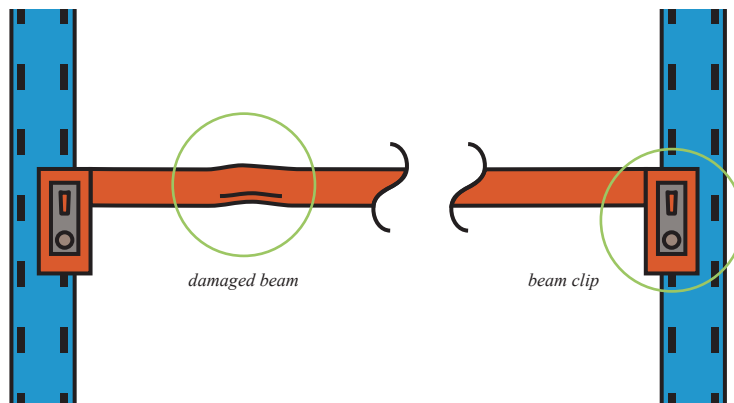

Beam clips and locking pins are designed to prevent the beam from being dislodged.

If a locking pin is damaged or missing it must be replaced.

## Recommended 1st beam height

As a guide, the first beam should not exceed 1500 mm in height above the ground.

Measure what you will store in the lowest level (typically ground level) and add 200 mm for clearance.

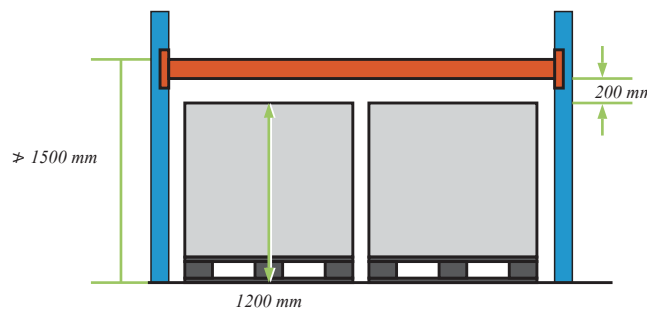

Installing your first beam more than 1500 mm above the ground will reduce the overall capacity of the bay and can cause bay instability.

## Overloading beams

### HOW TO CALCULATE BEAM DEFLECTION DEPTH

- ① Measure the length of the Beam (*span*)  
E.g. 2590 mm
- ② Attach a string from one end connector to the other across the beam
- ③ Measure the distance from the string to the bottom of the beam at the centre in an *unloaded capacity*  
E.g. 10 mm unloaded
- ④ Calculate the allowable deflection for the beam that you are using based on the current formula

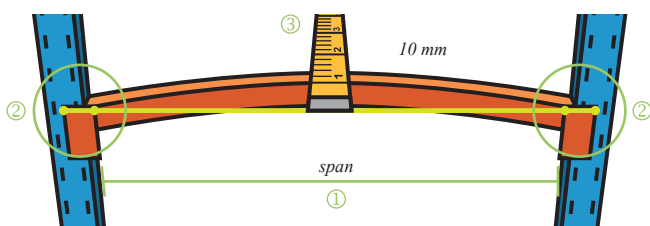

④ **Maximum beam deflection depth = span / 500**  
E.g.  $2590 / 500 = 5.2 \text{ mm max}$

Based on a 2590 beam the allowable deflection loaded needs to be less than 5.2 mm ( $2590 \text{ mm} / 500$ ). In this case the beam would need to be replaced. Still confused? Then give us a call.

### HOW TO CALCULATE HORIZONTAL BEAM DEFLECTION

- ① Measure the length of the Beam (*span*)  
E.g. 2590 mm
- ② Attach a string from one end connector to the other across the beam
- ③ Measure the distance from the string to the bottom of the beam at the centre in both a *loaded and unloaded capacity*
- ④ Calculate the allowable deflection for the beam that you are using based on the current formulas

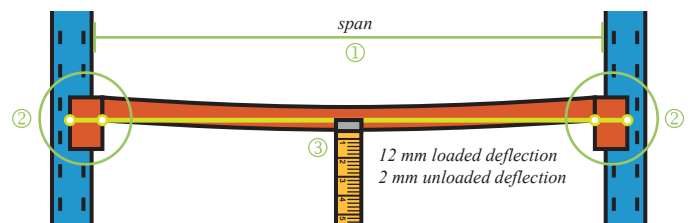

④ **Maximum deflection of a loaded beam = span / 180**  
E.g.  $2590 / 180 = 14.5 \text{ mm max}$

**Maximum deflection of an unloaded beam = span / 800**  
E.g.  $2590 / 800 = 3.2 \text{ mm max}$

In the above example the beam would be fine. Still confused? Then give us a call.



# Step by step | Uprights

## Out of plumb

For the safety of the racking and to keep its maximum weight capacity the *uprights must be level*.

To check, place a 1 m spirit level on an unloaded racking upright.

If the upright is found to be leaning measure the *out of plumb (x) distance* and compare to allowable *tolerance*.

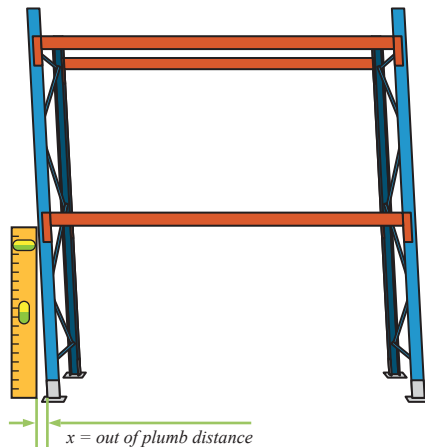

### OUT OF PLUMB TOLERANCE

As a rule, in a loaded capacity the upright cannot have an *out of plumb distance* of greater than 2 mm over a 1 m span.

*E.g. If you have a 6 m upright it will only have an allowable tolerance of 18 mm over the length of the upright. The same rule applies if the measurement is taken from front to back.*

Uneven or out of plumb upright can be rectified by un-bolting the beam and placing shim plates under the lower side, just give us a call and we can do that for you.

## Bracing damage

Damage to bracing often occurs during the day to day operation of the warehouse and must be noted during routine inspections.

If damage is within an acceptable tolerance then the racking may continue to be used. But if not, it must be deemed unsafe until bracing is replaced.

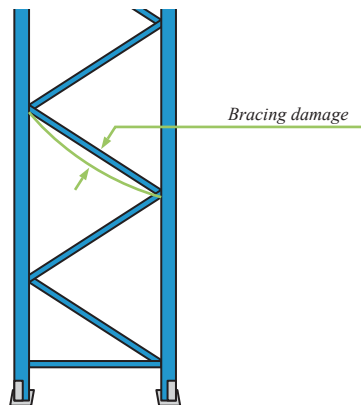

### BRACING DAMAGE CALCULATION

The maximum bracing damage in either direction or plane over a 1000 mm distance = 10.0 mm

The allowable damage for bracing less than 1000 mm in length is pro-rata the above.

*E.g. 5.0 mm over 500 mm*

## Upright damage

Damage can occur to the uprights either side to side or more common front to back.

As with bracing damage the racking may continue to be used provided the extent of the damage is within acceptable tolerances.

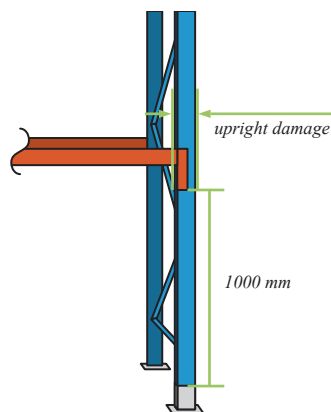

### UPRIGHT DAMAGE CALCULATION

#### Front to back damage

The maximum upright damage due to *impact in the direction of the bracing* over a 1000 mm distance is 3.0 mm.

If the damage is localised, the allowable damage for less than 1000 mm distance is pro-rata the maximum.

*E.g. 1.5 mm over 500 mm*

#### Side to side damage

The maximum upright damage due to *impact in the direction of the beams* over a 1000 mm distance is 5.0 mm.

If the damage is localised, the allowable damage for less than 1000 mm distance is pro-rata the maximum.

*E.g. 2.5 mm over 500 mm*

⚠ Where possible always test over 1000 mm span





# Protect your staff & your racking

## Keep a record of the racking design

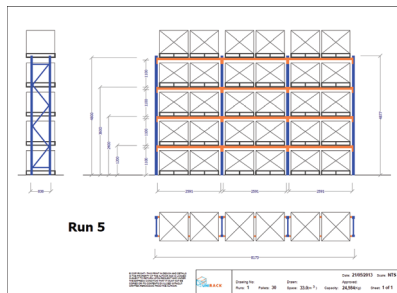

In accordance with the new standards, detailed drawings showing the layout of the run, capacity per pallet space and overall bay load must be provided with all new installations.

*The racking supplier must be notified if any changes are made and drawings therefore reproduced.*

## What you can do to protect your racking



In accordance with the new standards an upright protector (*min 400 mm high*) must be installed at the end of each run to prevent the upright being damaged through an impact.

*The row protector must also be designed and installed in accordance with current standards. Installing a protector is both good safety practice and the easiest way to ensure that your racking meets current standards.*

*Row protectors save you money by protecting your racking from damage from vehicle or forklift impact.*

## What you can do to protect your staff

If walkways are close to racking, fall barrier mesh panels should be installed. This prevents items being dislodged from above by a forklift operator on the other side.



⚠ Keep your racking checked and maintained to prevent unnecessary accidents and injury!



⚠ In addition, Queensland regulations require installers to be licensed. Unirack Australia holds a current licence (*lic #QBCC-15127645*).

Work **Safe**  
VICTORIA

Recommend You Check Your Racking EVERY 6 Months



### BARRIER PROTECTION

Barrier Protection are ideal for use indoors to protect valuable pallets. These safety barriers are constructed of heavy-duty, all-welded steel pipe.

Available Height  
500, 915, 1000, 1200 mm

Available Width  
900, 1200, 1238, 2038, 2200, 2257 mm



[www.unirack.com.au](http://www.unirack.com.au)



1300 864 725